

LEM 25.05.2019 Kamenz U15_mnl.-34

Kämpfer: 7

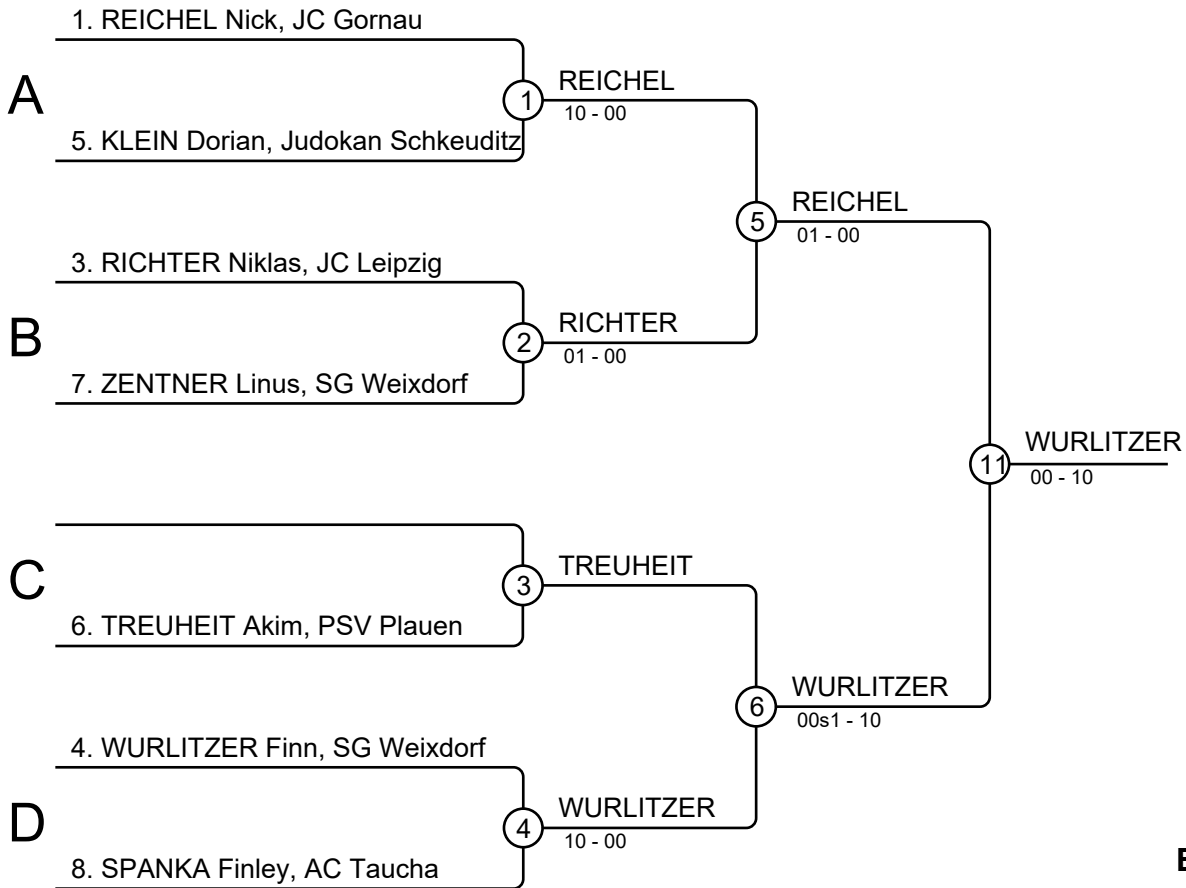

Ergebnisse

Platz	Name
1	WURLITZER Finn, SG Weixdorf
2	REICHEL Nick, JC Gornau
3	ZENTNER Linus, SG Weixdorf
3	RICHTER Niklas, JC Leipzig
5	TREUHEIT Akim, PSV Plauen
5	SPANKA Finley, AC Taucha
7	KLEIN Dorian, Judokan Schkeuditz
7	

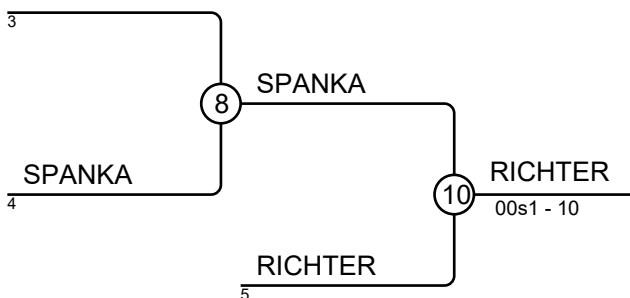
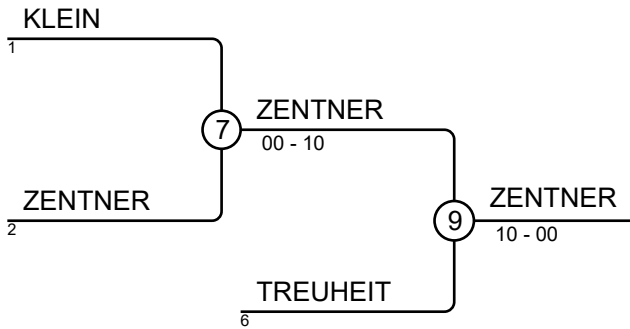

LEM 25.05.2019 Kamenz U15_mnl.-37

Kämpfer: 10

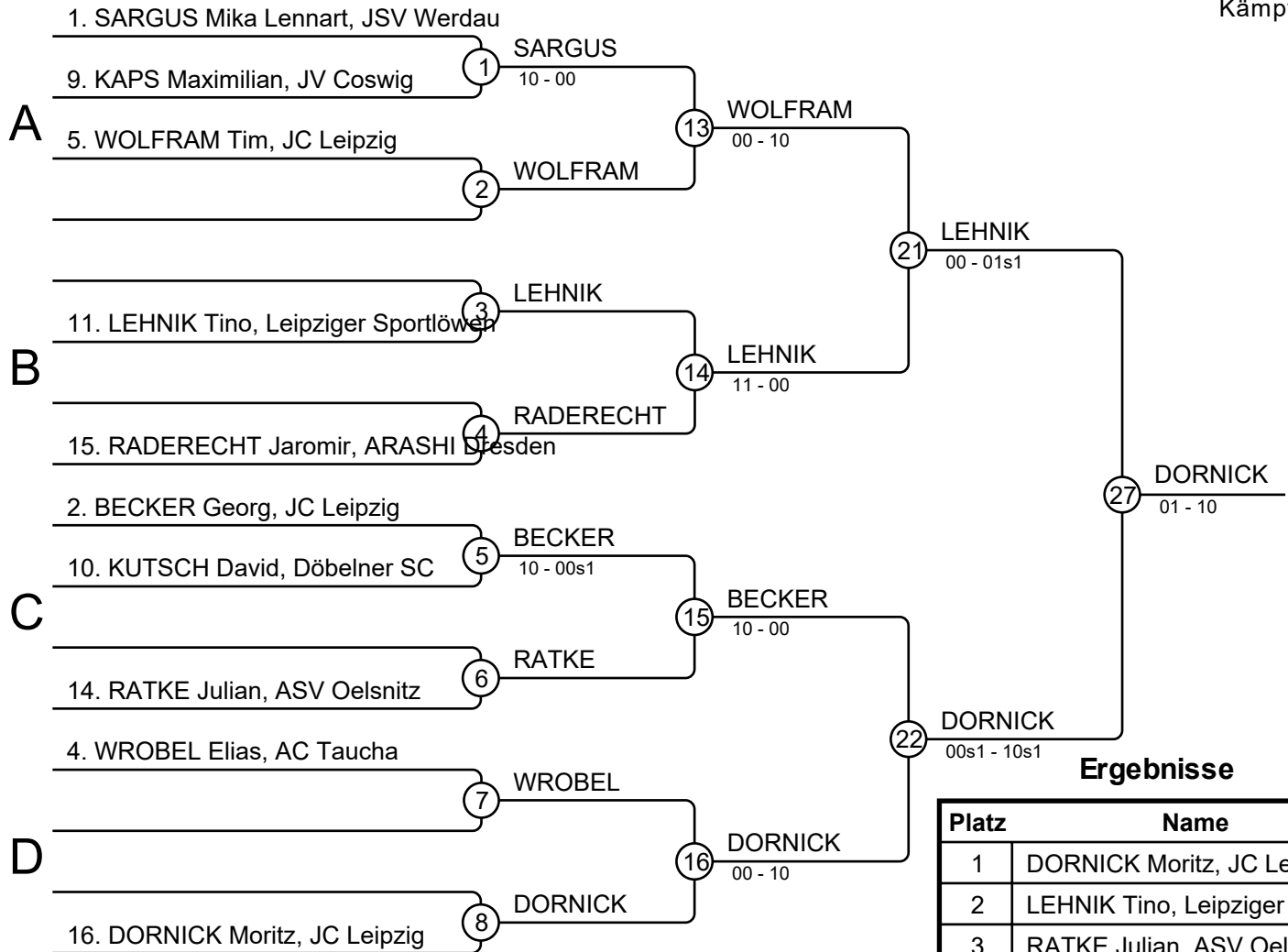

Ergebnisse

Platz	Name
1	DORNICK Moritz, JC Leipzig
2	LEHNIK Tino, Leipziger Sportlöwen
3	RATKE Julian, ASV Oelsnitz
3	BECKER Georg, JC Leipzig
5	WOLFRAM Tim, JC Leipzig
5	SARGUS Mika Lennart, JSV Werdau
7	WROBEL Elias, AC Taucha
7	RADERECHT Jaromir, ARASHI Dresden

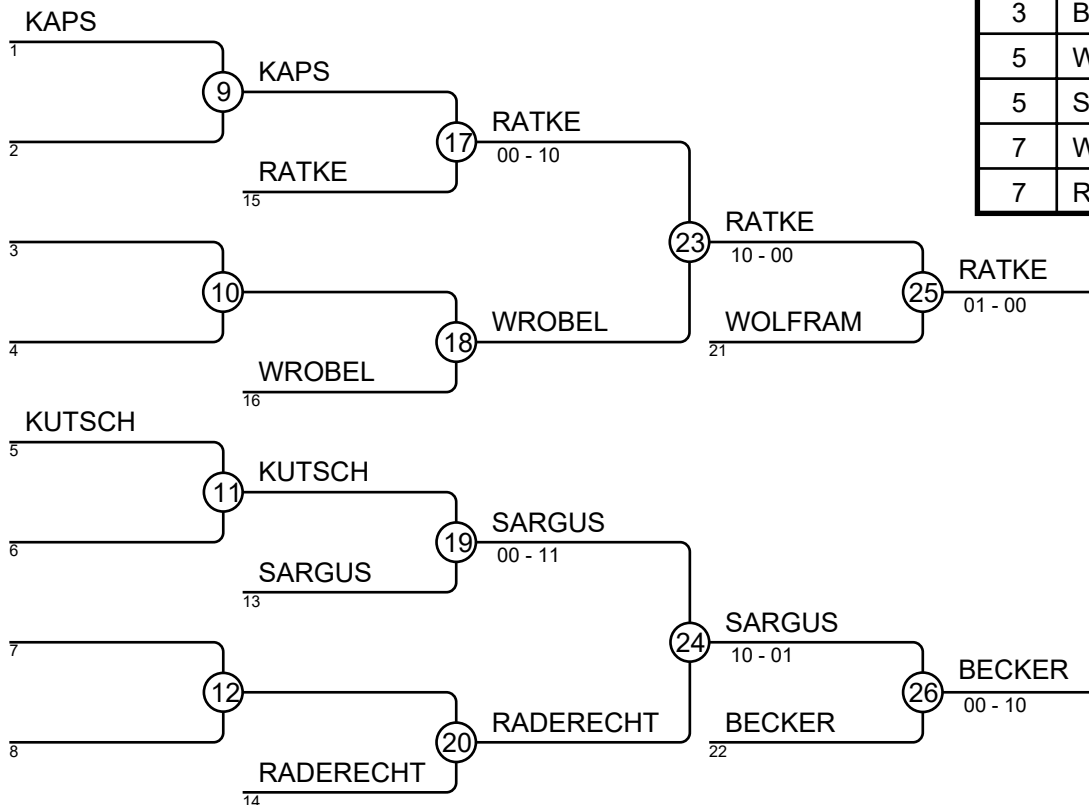

LEM 25.05.2019 Kamenz U15_mnl.-40

Kämpfer: 11

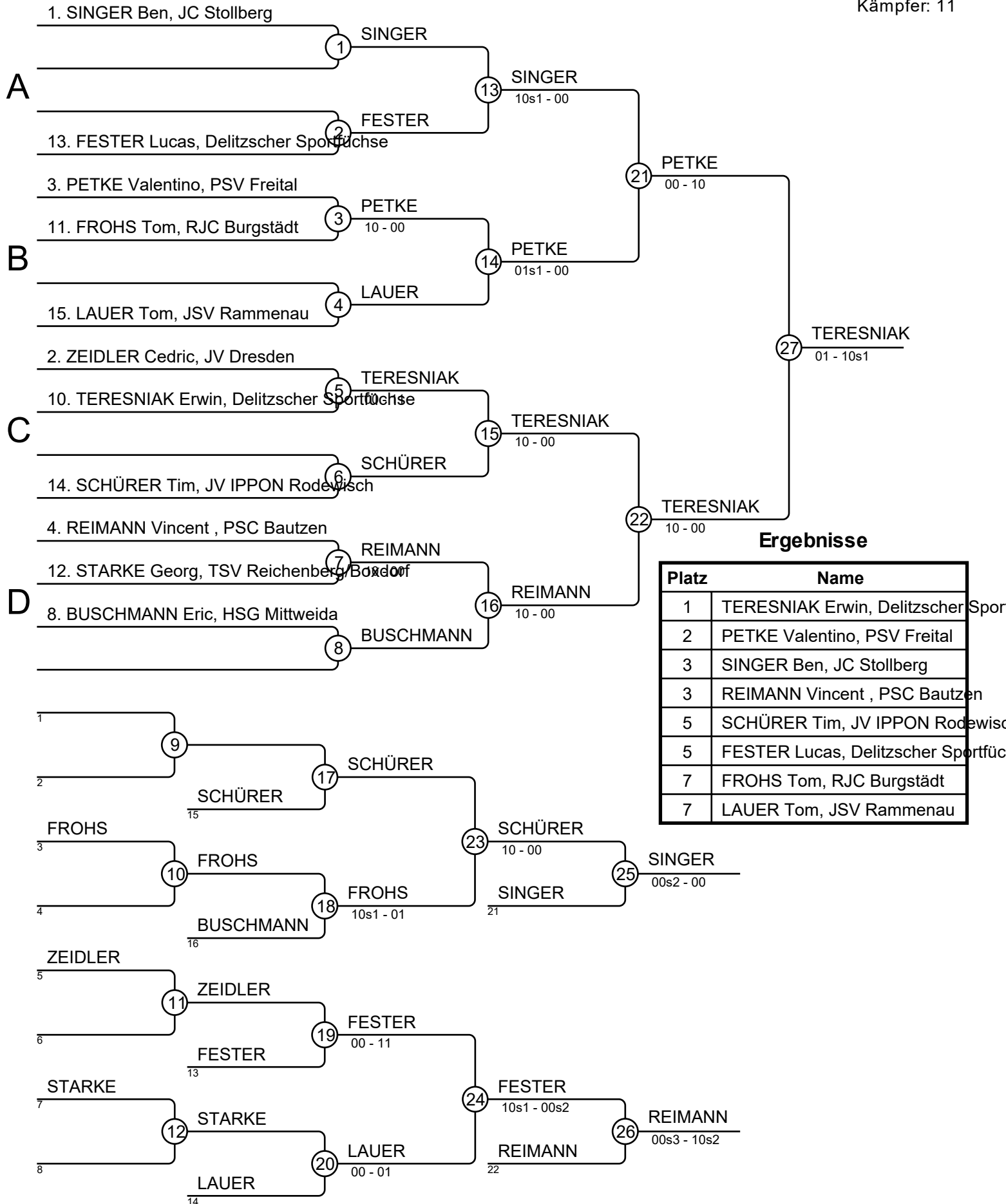

LEM 25.05.2019 Kamenz U15_mnl.-43

Kämpfer: 10

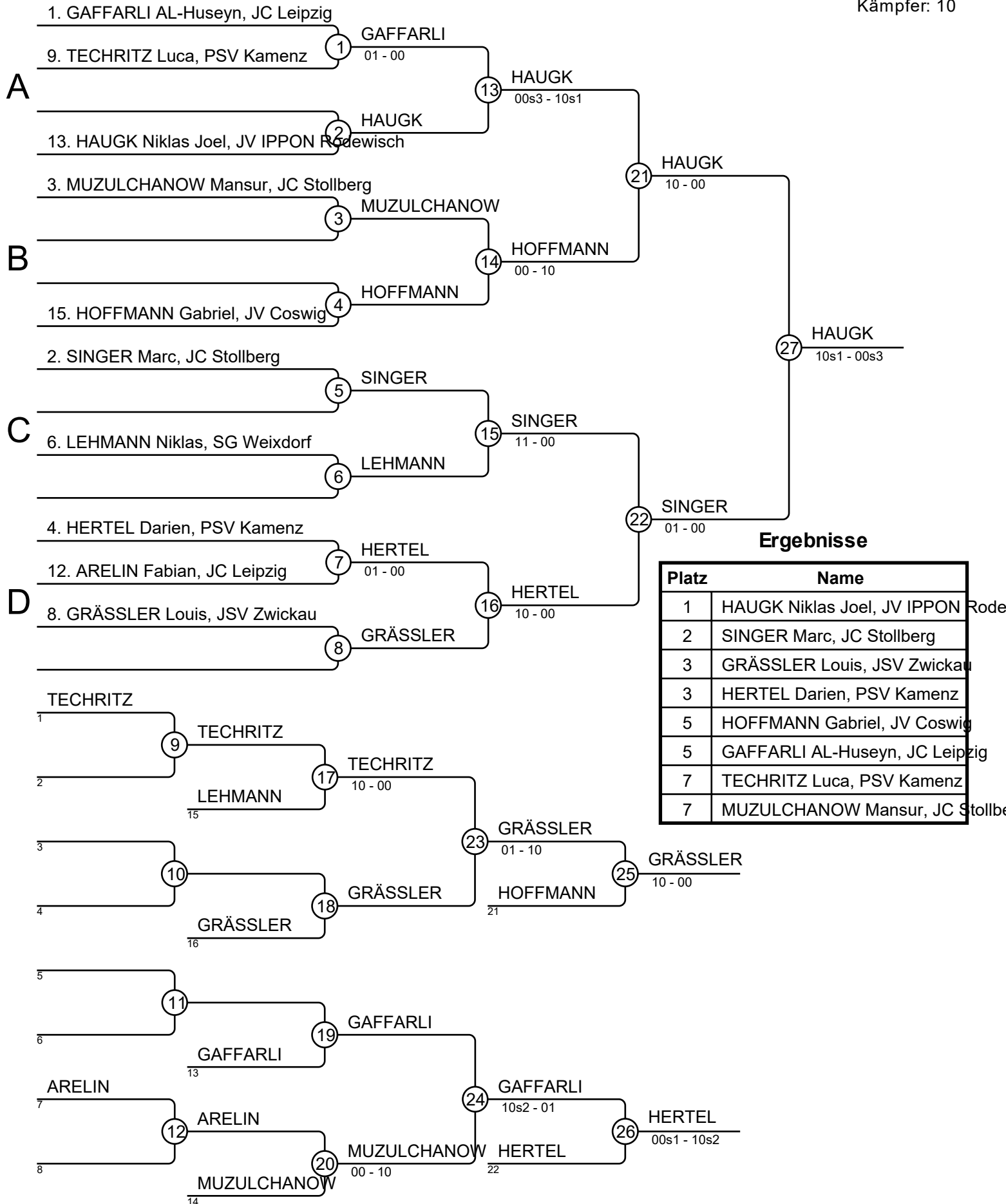

LEM 25.05.2019 Kamenz U15_mnl.-46

Kämpfer: 10

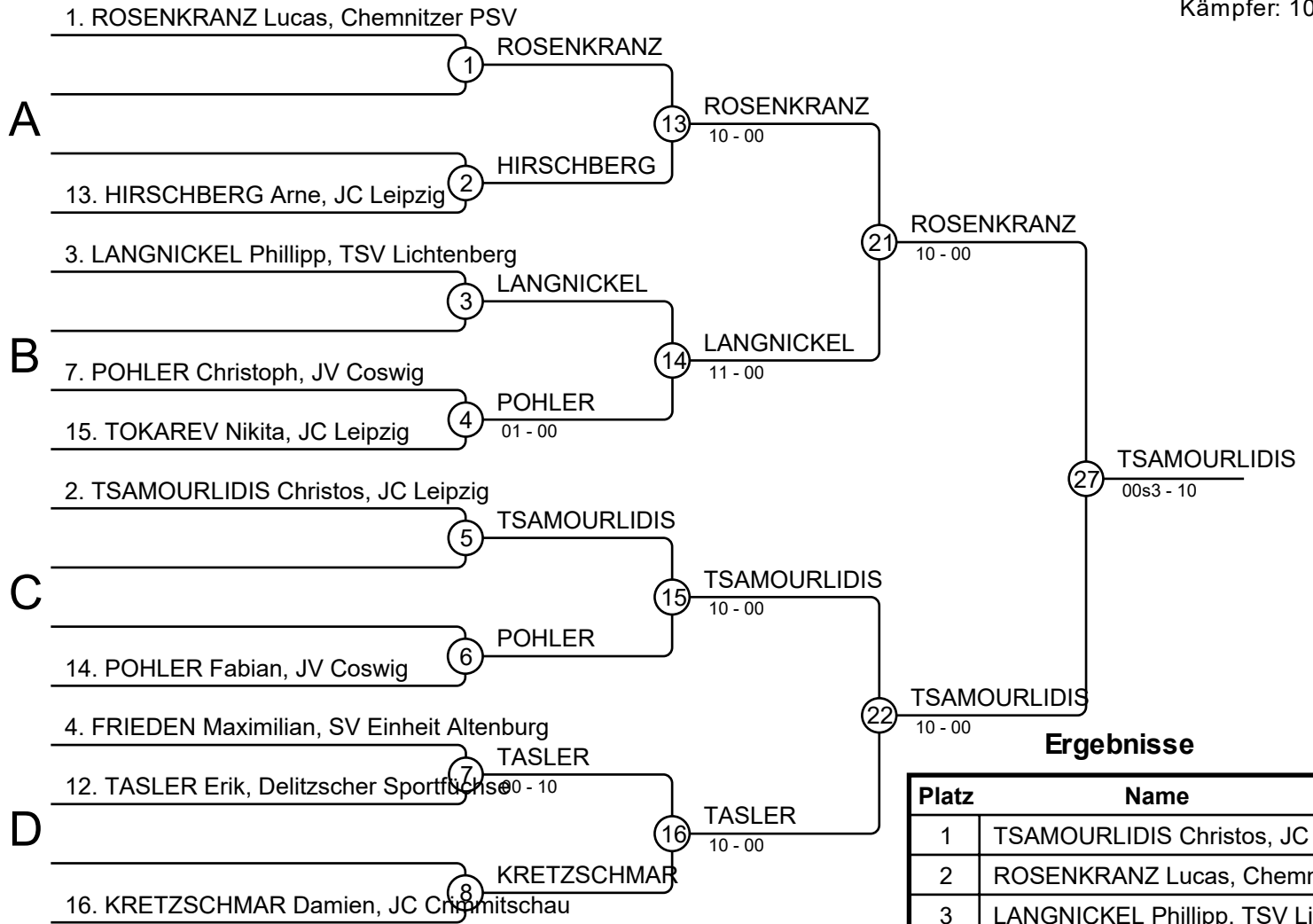

Platz	Name
1	TSAMOURLIDIS Christos, JC Leipzig
2	ROSENKRANZ Lucas, Chemnitzer P
3	LANGNICKEL Phillipp, TSV Lichtenb
3	TASLER Erik, Delitzscher Sportfuchs
5	KRETZSCHMAR Damien, JC Crimmi
5	HIRSCHBERG Arne, JC Leipzig
7	POHLER Fabian, JV Coswig
7	FRIEDEN Maximilian, SV Einheit Alte

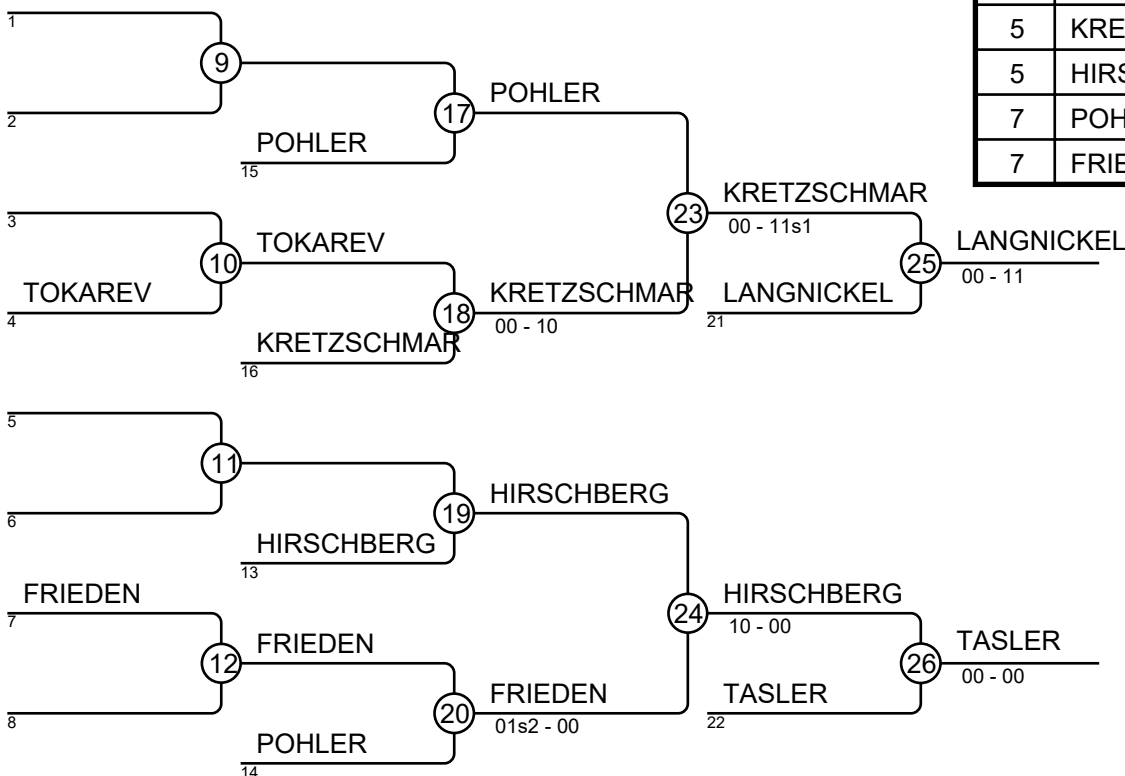

LEM 25.05.2019 Kamenz U15_mnl.-50

Kämpfer: 12

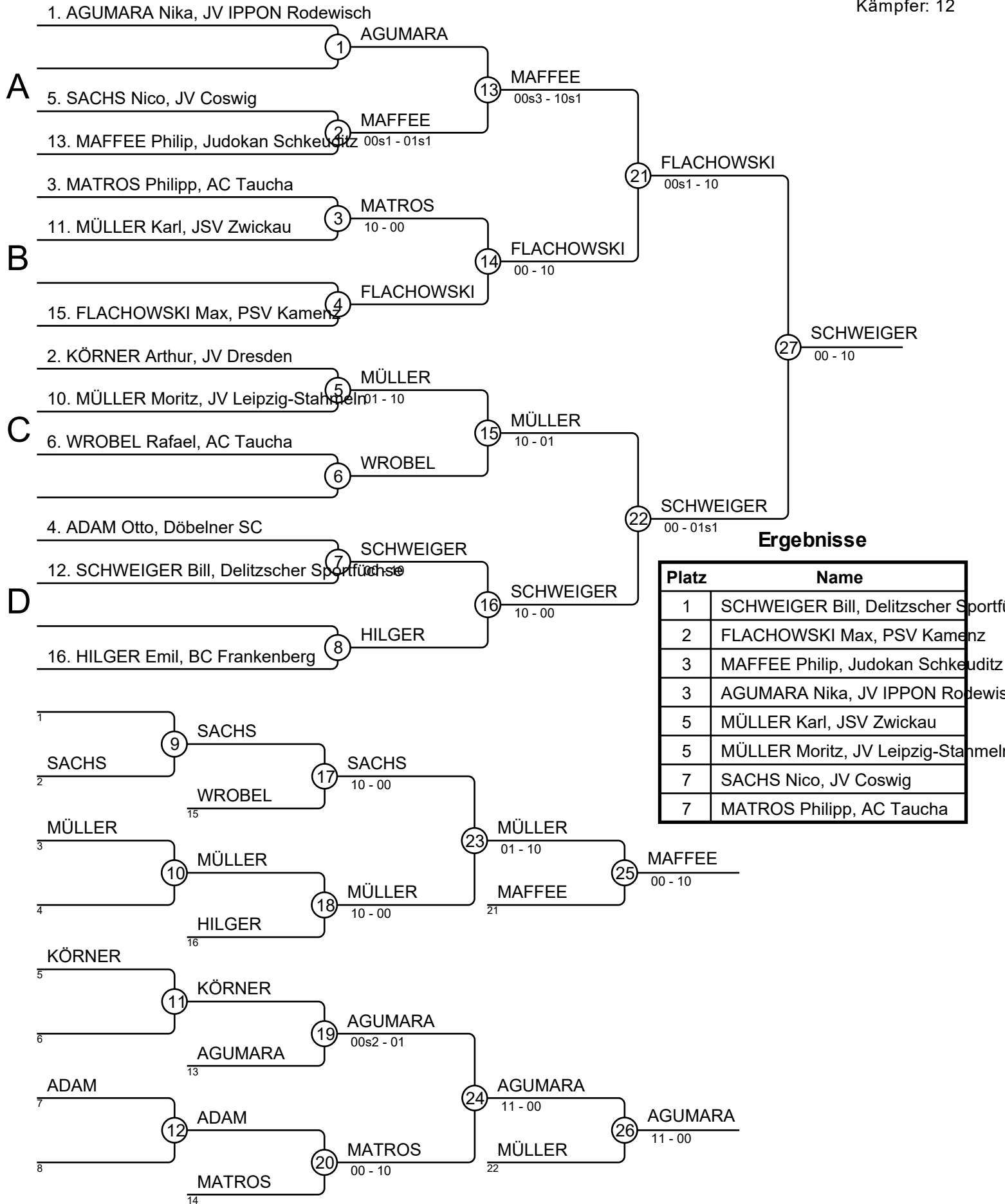

LEM 25.05.2019 Kamenz U15_mnl.-55

Kämpfer: 12

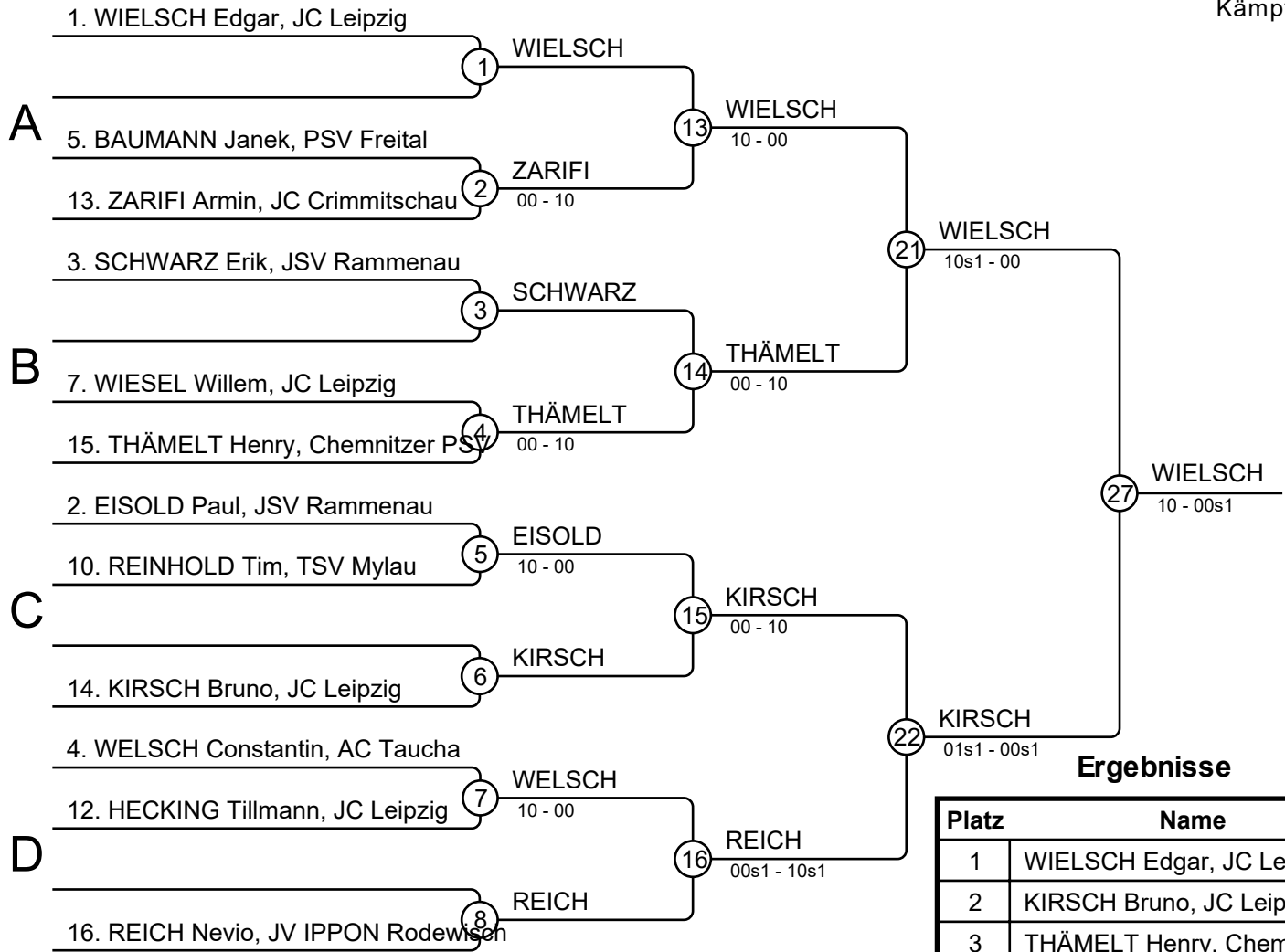

Ergebnisse

Platz	Name
1	WIELSCH Edgar, JC Leipzig
2	KIRSCH Bruno, JC Leipzig
3	THÄMELT Henry, Chemnitzer PSV
3	REICH Nevio, JV IPPON Rodewisch
5	EISOLD Paul, JSV Rammenau
5	REINHOLD Tim, TSV Mylau
7	WIESEL Willem, JC Leipzig
7	HECKING Tillmann, JC Leipzig

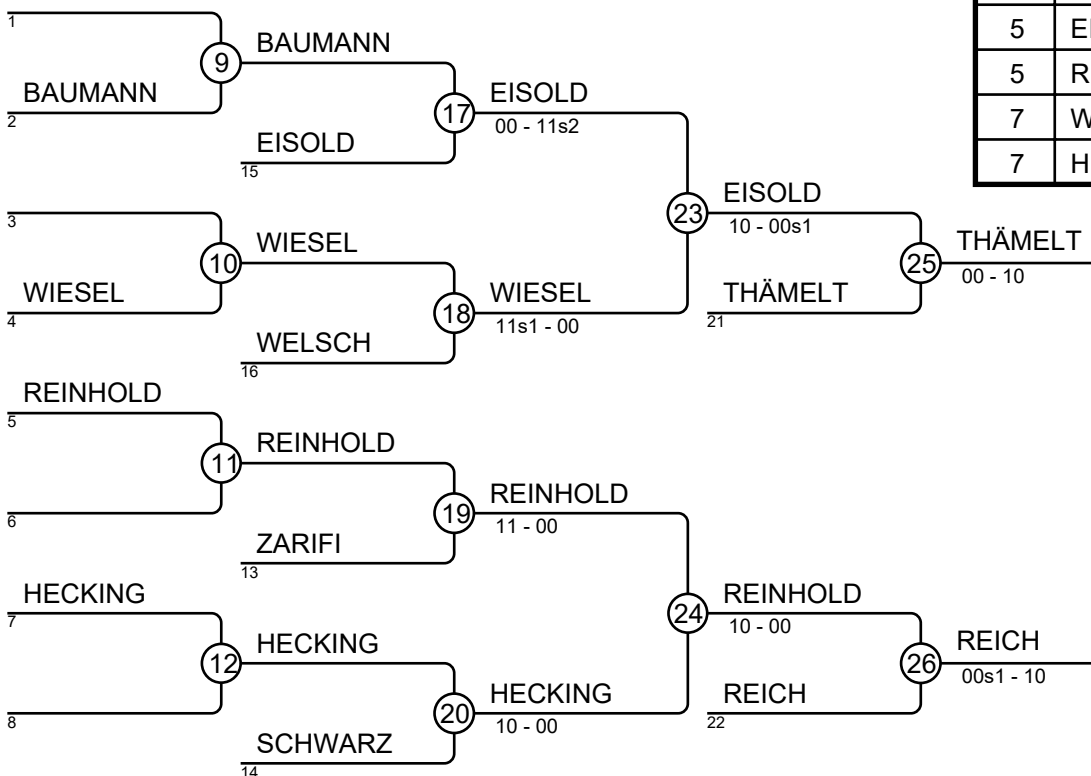

LEM 25.05.2019 Kamenz U15_mnl.-60

Kämpfer: 8

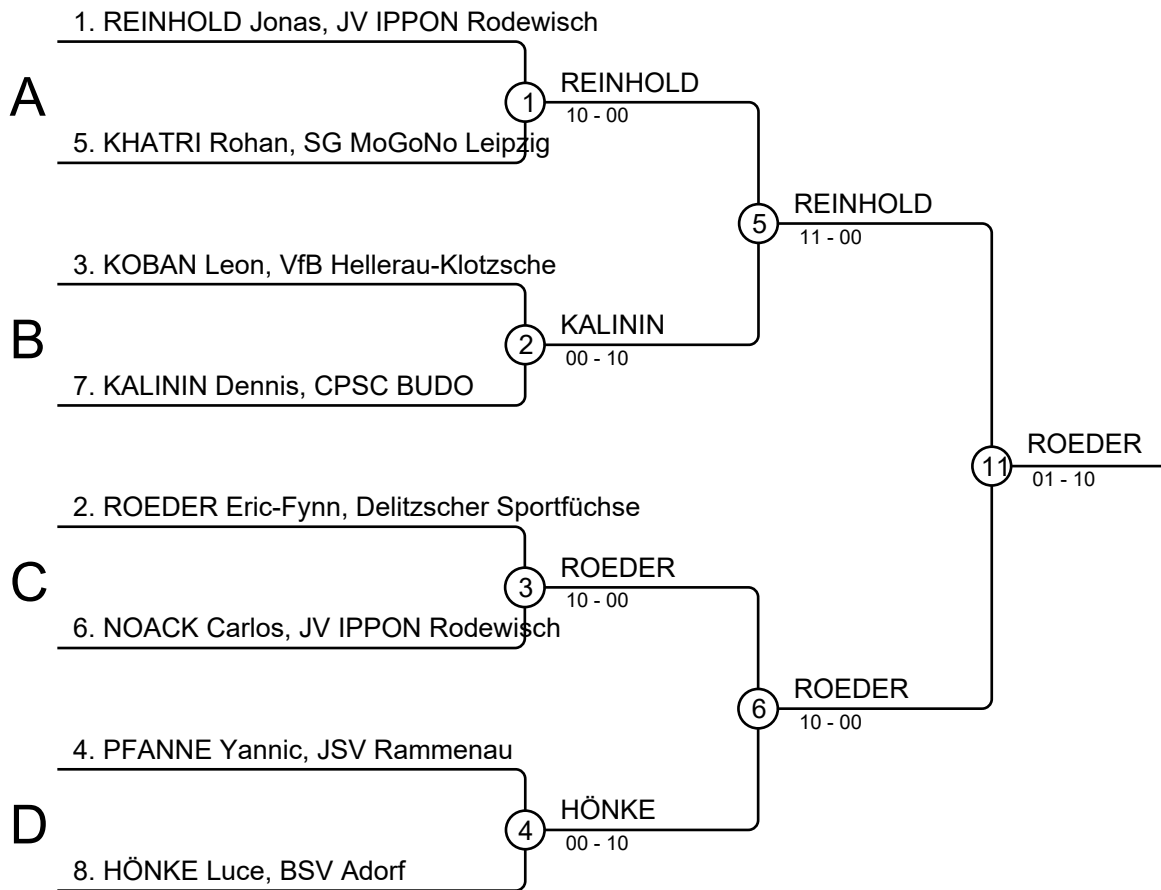

Ergebnisse

Platz	Name
1	ROEDER Eric-Fynn, Delitzscher Sportfuchse
2	REINHOLD Jonas, JV IPPON Rodewisch
3	HÖNKE Luce, BSV Adorf
3	NOACK Carlos, JV IPPON Rodewisch
5	KHATRI Rohan, SG MoGoNo Leipzig
5	KALININ Dennis, CPSC BUDO
7	KOBAN Leon, VfB Hellerau-Klotzsche
7	PFANNE Yannic, JSV Rammenau

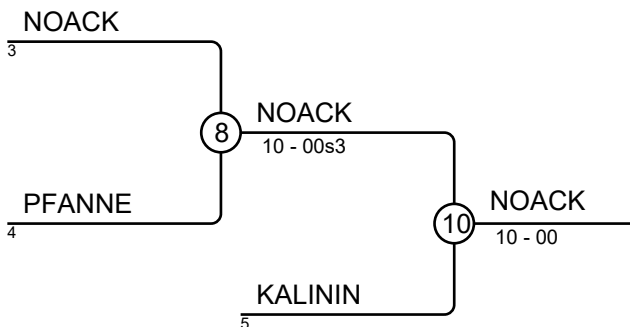
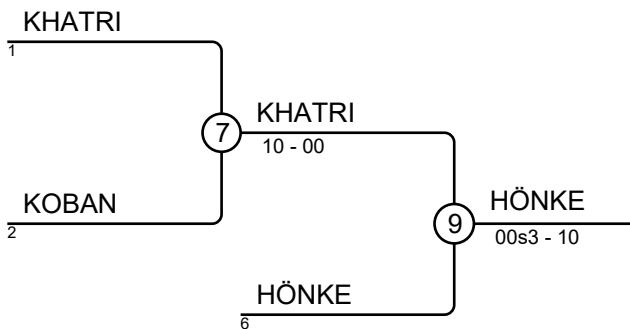

LEM 25.05.2019 Kamenz U15_mnl.-66

Kämpfer: 11

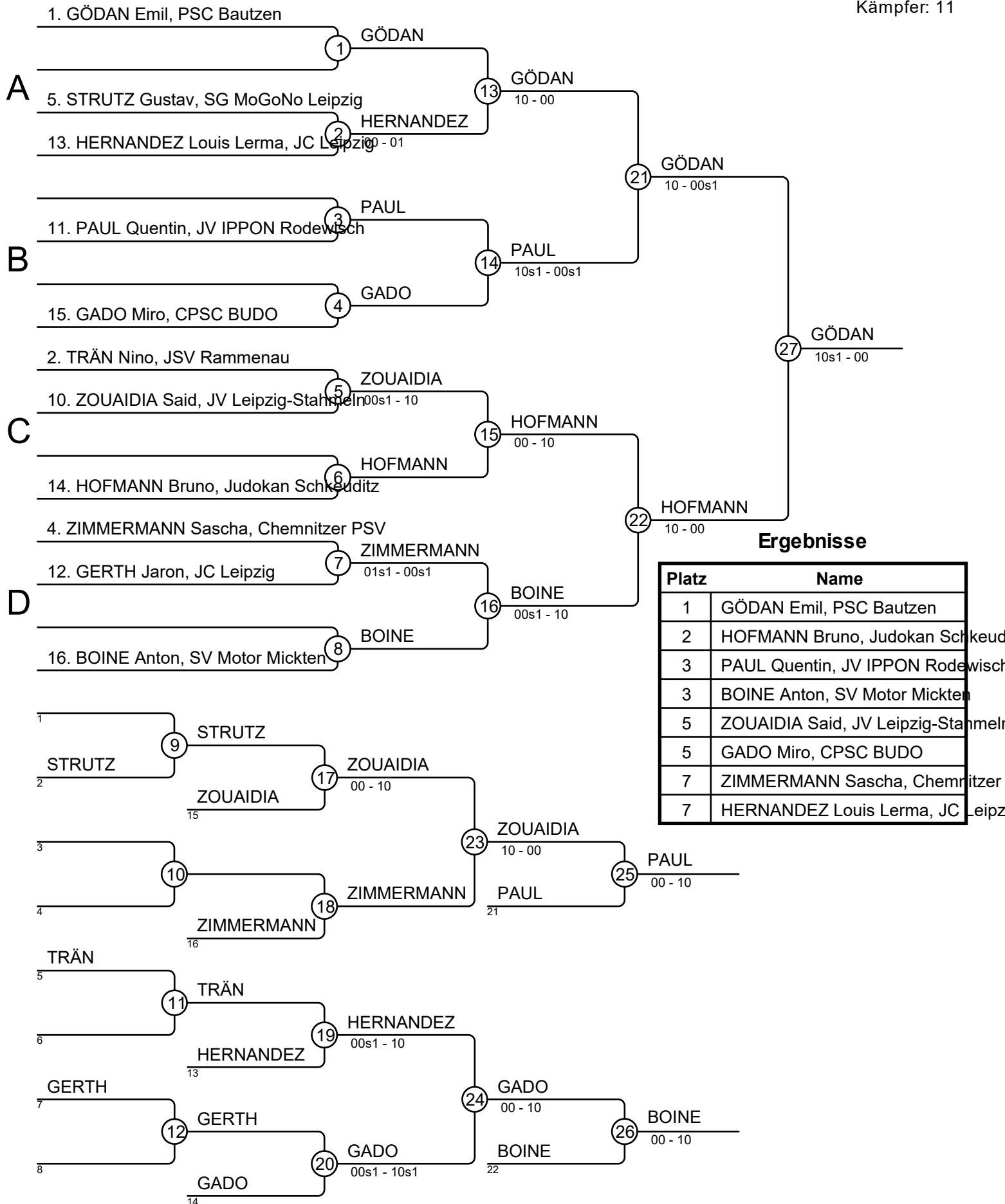

LEM 25.05.2019 Kamenz U15_mnl.+66

Kämpfer: 8

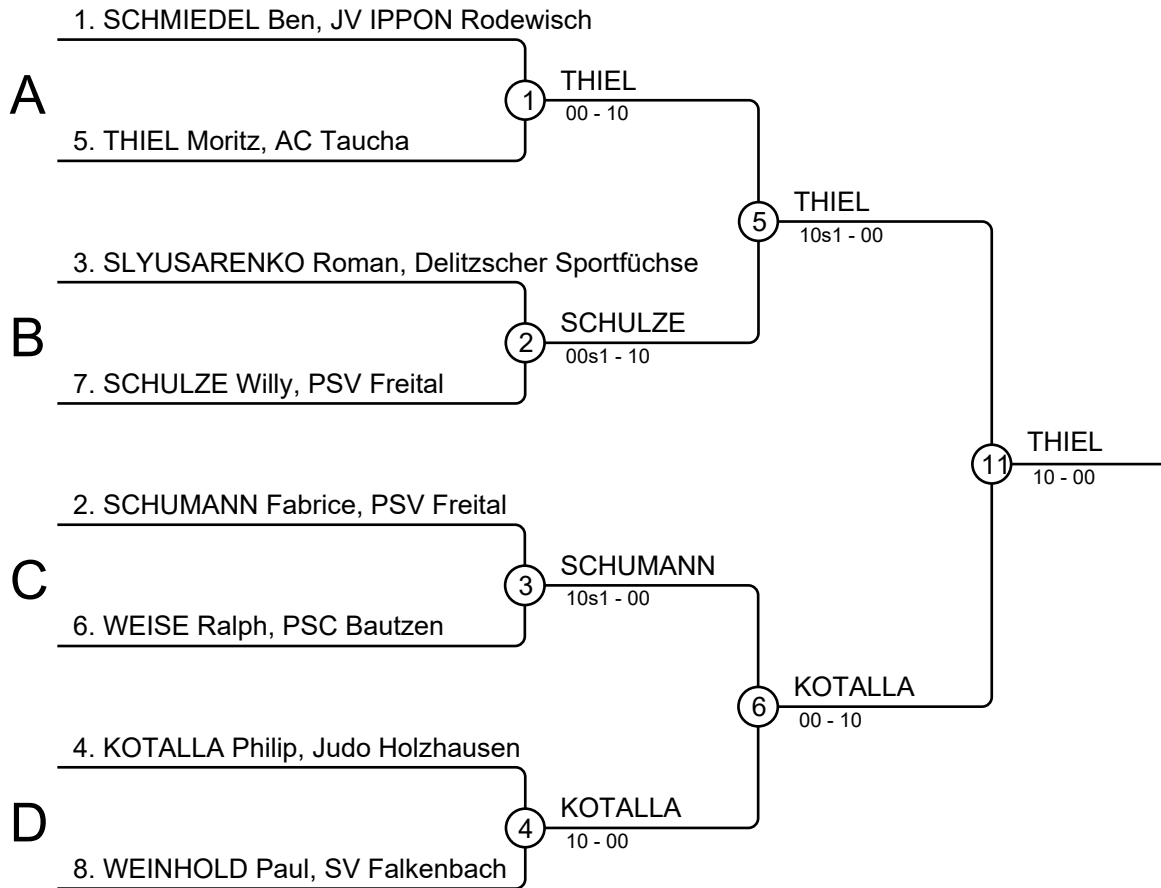

Ergebnisse

Platz	Name
1	THIEL Moritz, AC Taucha
2	KOTALLA Philip, Judo Holzhausen
3	SCHUMANN Fabrice, PSV Freital
3	SCHULZE Willy, PSV Freital
5	SLYUSARENKO Roman, Delitzscher Sportfuchse
5	WEISE Ralph, PSC Bautzen
7	SCHMIEDEL Ben, JV IPPON Rodewisch
7	WEINHOLD Paul, SV Falkenbach

